

7.2 EPIC® CIRC ON M23

Rundsteckverbinder / Circular connector / Connecteur circulaire

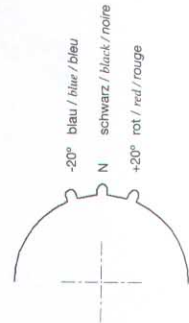
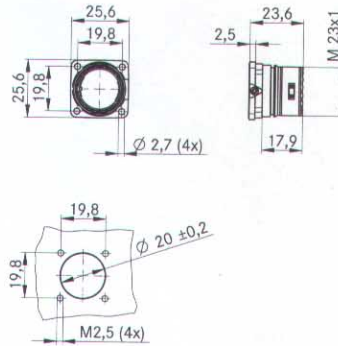

A1 / F6
Ansicht steckseitig
view from mating side
vue côté de connection

Bauform M23 A1 Einbaudose

Style M23 A1 panel base

Modèle M23 A1 boîte de montage

| Artikel part article | Art.Nr. part No. N° art. | Codierung coding codage | Kabelklemmung clamping range raccordement | VPE packing unit conditionnement |
|----------------------------|--------------------------------|-------------------------------|-------------------------------------------------|----------------------------------------|
| M23 A1 | 72004000 | N | - | 5 |
| M23 A1 | 72004010 | N | - | 20 |
| M23 A1 | 72004200 | +20° | - | 5 |
| M23 A1 | 72004210 | +20° | - | 20 |
| M23 A1 | 72004100 | -20° | - | 5 |
| M23 A1 | 72004110 | -20° | - | 20 |

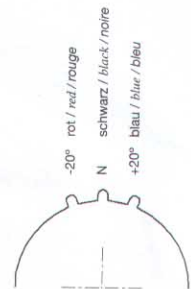
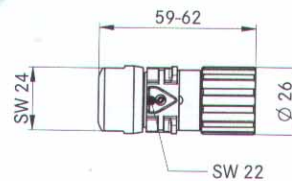

D6
Ansicht steckseitig
view from mating side
vue côté de connection

Bauform M23 D6 Kabelstecker

Style M23 D6 cable connector

Modèle M23 D6 fiche

| Artikel part article | Art.Nr. part No. N° art. | Codierung coding codage | Kabelklemmung clamping range raccordement | VPE packing unit conditionnement |
|----------------------------|--------------------------------|-------------------------------|-------------------------------------------------|----------------------------------------|
| M23 D6 | 72044030 | N | 7 - 10 | 5 |
| M23 D6 | 72044020 | N | 7 - 10 | 20 |
| M23 D6 | 72044000 | N | 9,5 - 13,5 | 5 |
| M23 D6 | 72044010 | N | 9,5 - 13,5 | 20 |
| M23 D6 | 72044230 | +20° | 7 - 10 | 5 |
| M23 D6 | 72044220 | +20° | 7 - 10 | 20 |
| M23 D6 | 72044200 | +20° | 9,5 - 13,5 | 5 |
| M23 D6 | 72044210 | +20° | 9,5 - 13,5 | 20 |
| M23 D6 | 72044130 | -20° | 7 - 10 | 5 |
| M23 D6 | 72044120 | -20° | 7 - 10 | 20 |
| M23 D6 | 72044100 | -20° | 9,5 - 13,5 | 5 |
| M23 D6 | 72044110 | -20° | 9,5 - 13,5 | 20 |

7.2 EPIC® CIRCON M23

Rundsteckverbinder / Circular connector / Connecteur circulaire

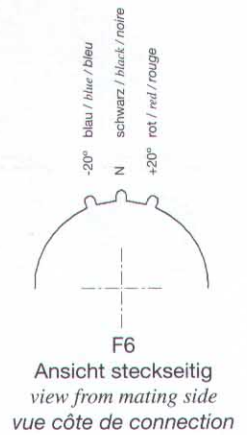
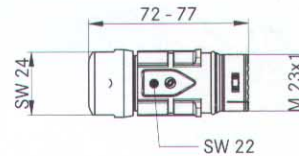

Bauform M23 F6 Kabelstecker
Style M23 F6 cable connector
Modèle M23 F6 fiche

| Artikel <i>part article</i> | Art.Nr. <i>part No. N° art.</i> | Codierung <i>coding codage</i> | Kabelklemmung <i>clamping range raccordement</i> | VPE <i>packing unit conditionnement</i> |
|------------------------------------|----------------------------------------|---------------------------------------|---------------------------------------------------------|------------------------------------------------|
| M23 F6 | 72064030 | N | 7 - 10 | 5 |
| M23 F6 | 72064020 | N | 7 - 10 | 20 |
| M23 F6 | 72064000 | N | 9,5 - 13,5 | 5 |
| M23 F6 | 72064010 | N | 9,5 - 13,5 | 20 |
| M23 F6 | 72064230 | +20° | 7 - 10 | 5 |
| M23 F6 | 72064220 | +20° | 7 - 10 | 20 |
| M23 F6 | 72064200 | +20° | 9,5 - 13,5 | 5 |
| M23 F6 | 72064210 | +20° | 9,5 - 13,5 | 20 |
| M23 F6 | 72064130 | -20° | 7 - 10 | 5 |
| M23 F6 | 72064120 | -20° | 7 - 10 | 20 |
| M23 F6 | 72064100 | -20° | 9,5 - 13,5 | 5 |
| M23 F6 | 72064110 | -20° | 9,5 - 13,5 | 20 |









7

7.2 EPIC® CIRCON M23

Rundsteckverbinder / Circular connector / Connecteur circulaire



Isolierkörper (Löt) Insulation body (solder) Isolant (à souder)

| | Ansicht steckseitig <i>view from mating side</i> <i>vue côté de connection</i> | Kontakte <i>contacts</i> <i>contacts</i> | Einsatz unbestückt <i>insert without</i> <i>contacts</i> <i>insert</i> <i>sans contacts</i> | Einsatz + Stiftkontakt Löt <i>insert + male</i> <i>contact solder</i> <i>insert</i> <i>+ contact mâle à souder</i> | Einsatz + Buchsenkontakt Löt <i>insert + female</i> <i>contact solder</i> <i>insert</i> <i>+ contact femelle à souder</i> | VPE <i>packing</i> <i>unit</i> <i>condition-</i> <i>nement</i> | |
|-----------------------------------------------------------------------------------------------|-------------------------------------------------------------------------------------------|-------------------------------------------------------------------------------------|------------------------------------------------------------------------------------------------------------|-----------------------------------------------------------------------------------------------------------------------------------|------------------------------------------------------------------------------------------------------------------------------------------|--------------------------------------------------------------------------------|---------|
| P-Teil / P-Part / P-Pièce Linksdrehend / turning anti-clockwise / rotation à gauche |  | 9 9 | 73002724 73002725 | 73002726 73002727 | 73002728 73002729 | 5 20 | |
| |  | 12 12 | 73002712 73002713 | 73002714 73002715 | 73002716 73002717 | 5 20 | |
| |  | 16 16 | 73002700 73002701 | 73002702 73002703 | 73002704 73002705 | 5 20 | |
| |  | 17 17 | 73008000 73008010 | 73028000 73028010 | 73018000 73018010 | 5 20 | |
| | E-Teil / E-Part / E-Pièce Rechtsdrehend / turning clockwise / rotation à droite |  | 9 9 | 73002730 73002731 | 73002732 73002733 | 73002734 73002735 | 5 20 |
| | |  | 12 12 | 73002718 73002719 | 73002720 73002721 | 73002722 73002723 | 5 20 |
| | |  | 16 16 | 73002706 73002707 | 73002708 73002709 | 73002710 73002711 | 5 20 |
| | |  | 17 17 | 73008500 73008510 | 73028500 73028510 | 73018500 73018510 | 5 20 |

Hinweis: Isolierkörper sind sowohl für Stift- als auch für Buchsenkontakte geeignet. Ein P-Teil und ein E-Teil für eine Verbindung verwenden.

Fett gedruckte Art.-Nr. = bestückte Einsätze als Vorzugstypen

Note: Male and female contacts can be fitted in the insulation body. Please use one P-Part and one E-Part for your connection.

Part No. Bold printed = recommended part (insert with contacts)

Conseil : les isolants conviennent à la fois aux contacts mâle et femelle. Utiliser une pièce P et une pièce E pour effectuer le raccordement.

N° art. en caractères gras = inserts équipés (types préconisés)

7.2 EPIC® CIRCON M23

Rundsteckverbinder / Circular connector / Connecteur circulaire

Kontakte

Contacts







Contacts

| Artikel part article | Art.-Nr. part No. N° art. | Typ type type | VPE packing unit conditionnement |
|-------------------------------------------------------------------------------------------------------------------------------|---------------------------------|-----------------------------------------------------------------------------------------------------|----------------------------------------|
| EPIC® M23 SCEM 1 mm AU 0,14 – 1,0 (100) EPIC® M23 SCEM 1 mm AU 0.14 – 1.0 (100) EPIC® M23 SCEM 1 mm AU 0,14 – 1,0 (100) | 72400000 | 1 mm Stift crimp 1 mm male crimp 1 mm, mâle, à sertir | 100 |
| EPIC® M23 SLEM 1 mm AU 1,0 (100) EPIC® M23 SLEM 1 mm AU 1.0 (100) EPIC® M23 SLEM 1 mm AU 1,0 (100) | 72402000 | 1 mm Stift löt 1 mm male solder 1 mm, mâle, à souder | 100 |
| EPIC® M23 BLEMS 1 mm 1,0 AU (100) EPIC® M23 BLEMS 1 mm 1.0 AU (100) EPIC® M23 BLEMS 1 mm 1,0 AU (100) | 72402600 | 1 mm Buchse schlitzz löt 1 mm female solder slotted 1 mm, femelle, à entaille, à souder | 100 |
| LS1 D BCEMS 1 mm AU 0,14 – 11,0 (100) LS1 D BCEMS 1 mm AU 0.14 – 1.0 (100) LS1 D BCEMS 1 mm AU 0,14 – 11,0 (100) | 74200600 | 1 mm Buchse schlitzz crimp 1 mm female crimp slotted 1 mm, femelle, à entaille, à sertir | 100 |
| LS1 D BCEMD 1 mm AU 0,14 – 1,0 (100) LS1 D BCEMD 1 mm AU 0.14 – 1.0 (100) LS1 D BCEMD 1 mm AU 0,14 – 1,0 (100) | 74034500 | 1 mm Buchse Drahtfeder crimp 1 mm female crimp hyperboloid 1 mm, femelle, à ressort, à sertir | 100 |

Werkzeuge und Zubehör

Tools and Accessories

Outils et accessoires

| Artikel part article | Art.-Nr. part No. N° art. | Bemerkungen remark remarques | VPE packing unit conditionnement | Bild picture image |
|--------------------------------------------------------------------------------------------------------------|---------------------------------|--------------------------------------------------------------------------------------------------------------------|----------------------------------------|---------------------------------------------------------------------------------------|
| Handcrimpzange Crimping tool Pince à sertir manuelle | 11148000 | im Servicekoffer with service case dans la mallette de réparation | 1 |  |
| Locator für EPIC® CIRCON Locator for EPIC® CIRCON Localiseur pour EPIC® CIRCON | 11148300 | | 1 |  |
| M23 Ausbau-Werkzeug für Einsatz M23 Removal tool for 1 mm contacts Outil de démontage pour inserts M23 | 75017400 | für Typ A1 for Typ A1 pour Type A1 | 1 |  |
| M23 A Schraubkappe M.F. M23 A screw cap M.F. Capuchon à visser M23 A M.F. | 75018110 | Metaldeckel für A1 Metal screw cap for A1 Couvercle métallique pour A1 | 20 |  |
| M23 A, B, F, G Schraubkappe M.F. M23 A, B, F, G, screw cap M.F. Capuchon de protection M23 A, B, F, G | 75018010 | Metaldeckel für A1, F6, F7 Metal screw cap for A1, F6, F7 Couvercle métallique pour A1, F6, F7 | 20 |  |
| M23 D Schutzkappe M23 D protection cap Capuchon de protection M23 D | 75007710 | Kunststoffdeckel für D6 Plastic protection cap for D6 Couvercle en plastique pour D6 | 20 |  |
| M23 A, B, F, G Schutzkappe M23 A, B, F, G protection cap Capuchon de protection M23 A, B, F, G | 75007810 | Kunststoffdeckel für A1, F6, F7 Plastic protection cap for A1, F6, F7 Couvercle en plastique pour A1, F6, F7 | 20 |  |